

BETALINE

Technical data pages by Formrack

Betaline 19" Free Standing Rack
Cabinet Reference Rack:36U 600x800

FORMRACK®



General Features

- Betaline cabinets have four side openable, lockable and easily removable covers.
- The rear and side covers are made by DKP sheet and the front side is made by 4 mm thick, impact-resistant, tempered and smoked-colored glass which is supported by metal frames.
- The frame and corner profiles have screwed structure at the interior surface
- Ventilation can be provided by cooling units with 2 or 4 fans.
- 36U height option.
- There are four 19" mounting profiles which can be adjusted in depth according to the need in the cabinet
- Mounting profiles have U markings that facilitate the mounting process.
- At the bottom part of the cabinets, there is a sliding and dust-protected brushed cable entry. These entries are available in two locations, from bottom to top.
- Painted by impact-resistant, high strength, electrostatic Ral 9005 texture black color or Ral 7035 gray.
- All test procedures have been carried out and has RoHS, CE, EN 61587-1 standards.

Technical Descriptions

Dimensions W*D	: W:600 mm D:780 mm
Available U - Sizes	: 36U
Paint Type	: Electrostatic powder paint
Standarts	: In accordance with the standard TS EN IEC 61587-1: 2022 / ISO9001-2015 / ISO14001-2015 / ISO 45001-2018 / ISO 27001:2017 / RoHS / UL 2416
Material	: Sheet Steel, DIN EN 1030-99 / DC-01 6112 / DC-7122
Load Carrying Capacity	: 800kg / 1 763.69lbs
IP rating	: IP20
Available Colors	: Ral 9005 Black / Ral 7035 Light Gray (Contact your sales representative for different colors)

BETALINE

FORMRACK

Address: Akcaburgaz Mah. 592. Sokak No:10 B Blok 34522 Esenyurt - Istanbul - Türkiye
T: +90 212 565 56 50 / F: +90 212 567 40 46 www.formrack.com / sales@formrack.com

BETALINE

Technical data pages by Formrack

Betaline 19" Free Standing Rack
Cabinet Reference Rack:36U 600x800

FORMRACK®



■ RAL 9005



■ RAL 7035



DOORS

Front Doors



Single Glass Door



Single Perforated Door



Double Perforated Door

Rear Doors



Single Solid Metal Door



Double Solid Metal Door

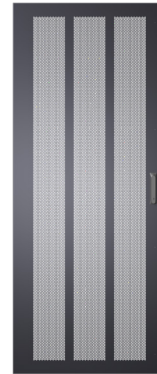

Single Perforated Door



Double Perforated Door

BETALINE

FORMRACK

Address: Akcaburgaz Mah. 592. Sokak No:10 B Blok 34522 Esenyurt - İstanbul - Türkiye
T: +90 212 565 56 50 / F: +90 212 567 40 46 www.formrack.com / sales@formrack.com

BETALINE

Technical data pages by Formrack

Betaline 19" Free Standing Rack
Cabinet Reference Rack:36U 600x800

FORMRACK®

Exploded View

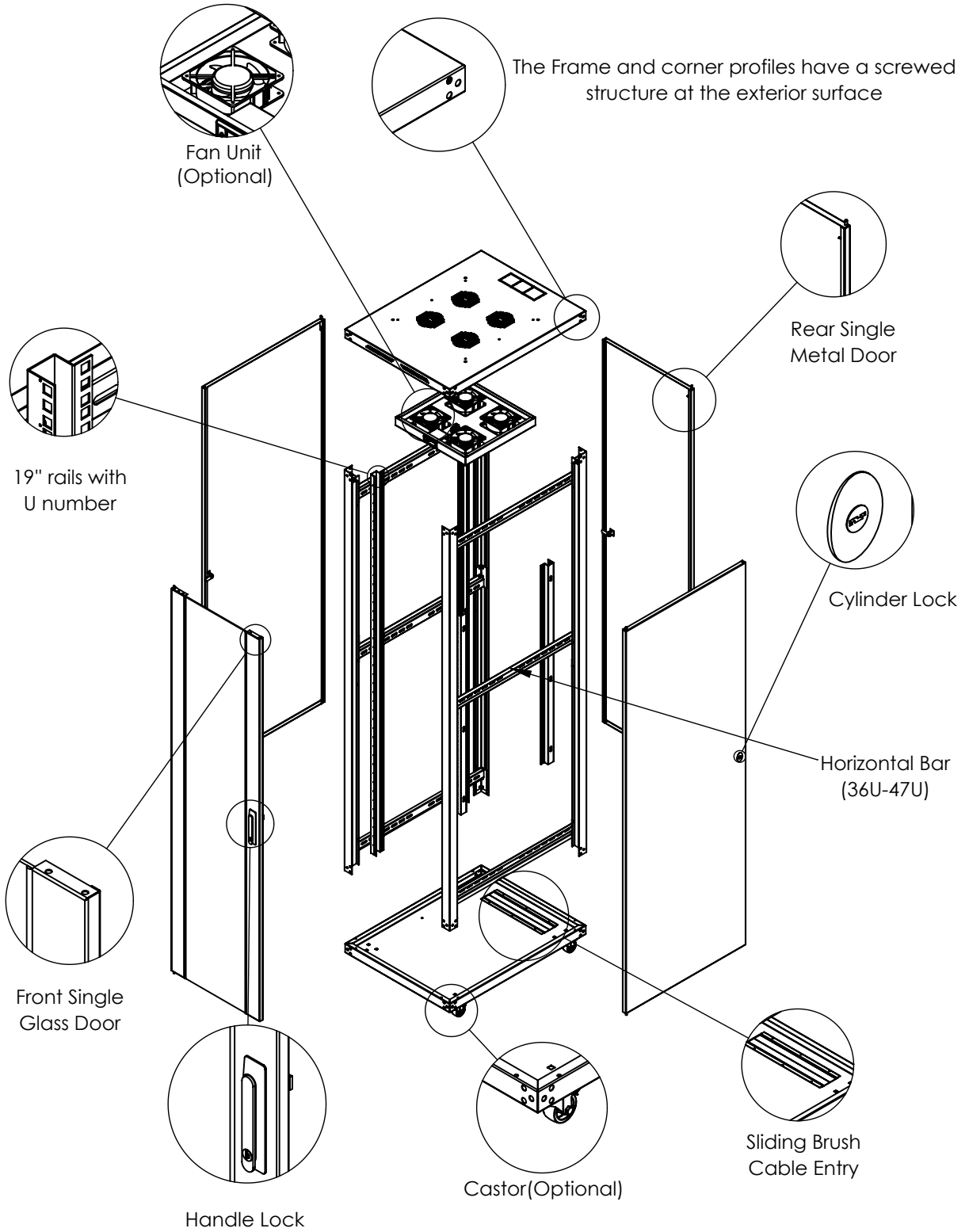

BETALINE

FORMRACK

Address: Akcaburgaz Mah. 592. Sokak No:10 B Blok 34522 Esenyurt - Istanbul - Türkiye
T: +90 212 565 56 50 / F: +90 212 567 40 46 www.formrack.com / sales@formrack.com

BETALINE

Technical data pages by Formrack

Betaline 19" Free Standing Rack
Cabinet Reference Rack:36U 600x800

FORMRACK®

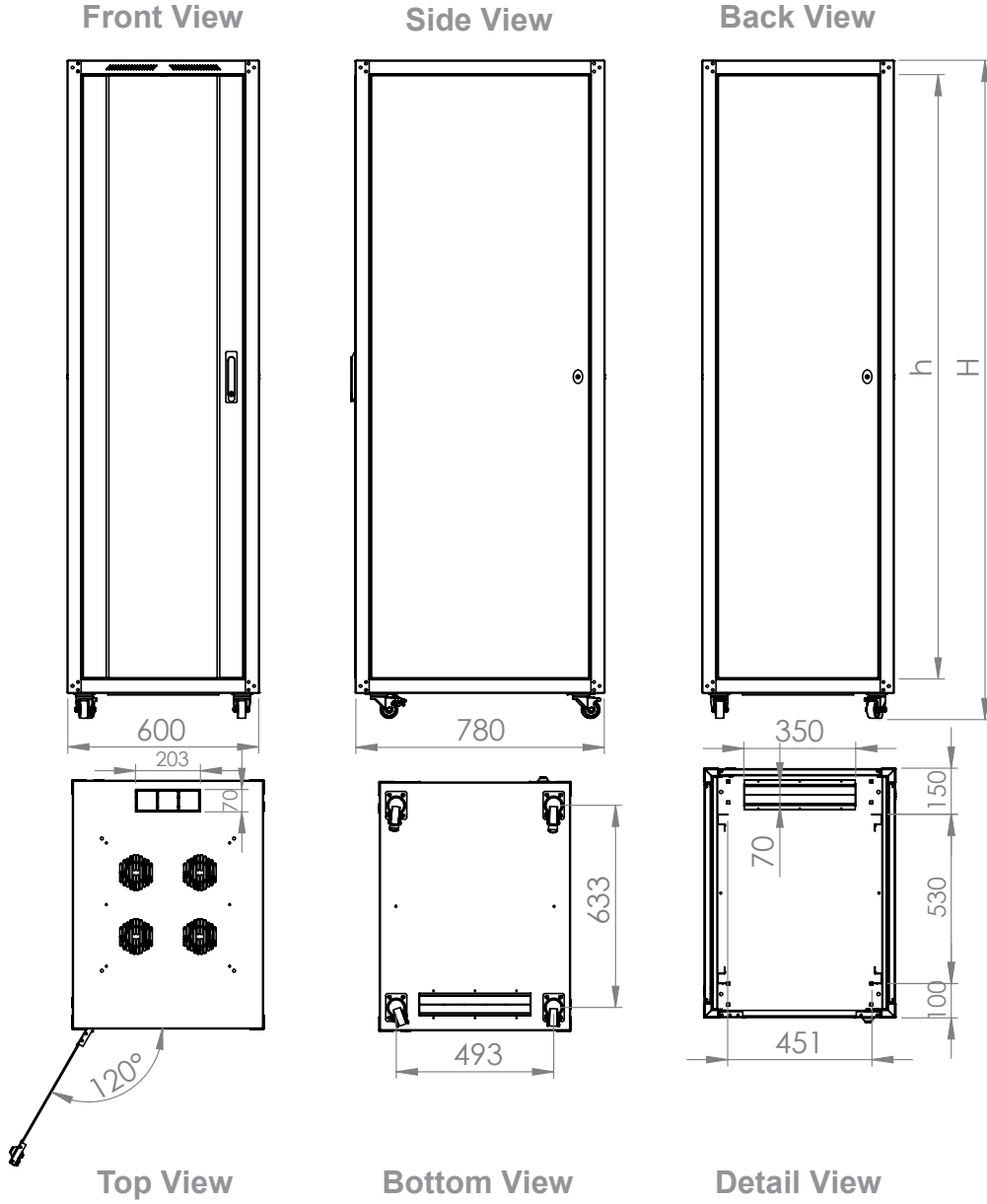

Product Number	Product Name	Dimensions (WxDxH) (mm)	U	H (mm)	h (mm)	Weight (kg)
FORM BETA-36U6080	36U 600x800 BETALINE FREE STANDING CABINET	600x780x1829	36	1829	1603	74

BETALINE

FORMRACK

Address: Akcaburgaz Mah. 592. Sokak No:10 B Blok 34522 Esenyurt - Istanbul - Türkiye
T: +90 212 565 56 50 / F: +90 212 567 40 46 www.formrack.com / sales@formrack.com

BETALINE

Technical data pages by Formrack

Betaline 19" Free Standing Rack
Cabinet Reference Rack:36U 600x800

FORMRACK®

STANDARDS

PROTECTION INDEX

- IP20 According to TS 3033 EN 60529
- IP20 :Rigid test rod diameter of 12 mm, 80 mm long (as specified by the standard) is pushed against any openings of the enclosure with the force of 10N

MECHANICAL PERFORAMANCE

- EN 61587-1 5.2.1 / 5.2.3
- Static mechanical load test (Performance level SL06)
- Resonance point detection test IEC 60068-2-6
- Rolling Test (TS EN IEC 61587-1)
- Vibration test (IEC 60068-2-6)
- Shock test IEC 60068-2-27)

CLIMATIC TESTS (Performance level C2)

- Cold (IEC 60068-2-1) Temperature of the exposure: -25°C +/-3°C
- Dry heat (IEC 60068-2-2) Temperature of the exposure: +70°C +/-2°C
- Damp heat cyclic (IEC 60068-2-30)

INDUSTRIAL ATMOSPHERE (Performance level A2)

- Sulphur dioxide test and hydrogen sulphide test IEC 60068-2-42, IEC 60068-2-43, IEC 60068-2-49

GROUNDING CONTINUITY

EN 61587-1 / EN 61010-1

The continuity of the protection circuit is in accordance with the standard regulations, measured resistance was less than 0.1 Ohm.

SHEET METAL: TS EN ISO 9001:2008; TS EN 10130 :2006; DIN EN 1030- EQV; BS EN 1030-EQV; NF A36-401.

ELECTROSTATIC POWDER PAINT: ISO 9001:2015 ASTM D523; ASTM D2794; DIN EN ISO 2811-1; ASTM D1186/D1400; Ral:9005 or Ral:7035.

VENTILATION UNITS (Fan Unit) TS EN 62368-1:2020 — AC:2020 — A11:2020

TEMPERED SAFETY GLASS " EN 12150 – 2 Glass, Tempered, secure " Mechanical strength test result: Bending strength minimum 120 N/ mm²

CONNECTION COMPONENTS (screw, nut, washer etc.)" TS EN ISO 7045; TS EN ISO 4032; RoHS IEC 62321 "

WHEEL SET " TS EN 12532 , TS EN 12533 , RoHS IEC 62321:2008"

LOCKS SYSTEMS "DIN-EN ISO 1043-1 PA6 GFR 30; DIN-EN 1774-ZnAl4Cu1.

BETALINE

FORMRACK

Address: Akcaburgaz Mah. 592. Sokak No:10 B Blok 34522 Esenyurt - Istanbul - Türkiye
T: +90 212 565 56 50 / F: +90 212 567 40 46 www.formrack.com / sales@formrack.com